



Part no.: 50136540
LCS-2M18B-F08NNC-K020V
Capacitive sensor



Figure can vary

Contents

- . Technical data
- . Dimensioned drawings
- . Electrical connection
- . Circuit diagrams
- . Operation and display
- . Accessories
- . Notes



Part no.: 50136540 – LCS-2M18B-F08NNC-K020V – Capacitive sensor

Technical data

Basic data	
Series	LCS-2
Switching distance S_n	2 ... 8 mm
Assured switching distance	6.5 mm

Electrical data	
Protective circuit	Short circuit protected Polarity reversal protection

Performance data	
Supply voltage	10 ... 30 V, DC
Residual ripple	0 ... 10 %
Open-circuit current	10 mA
Rated operating current	300 mA

Outputs	
Number of digital switching outputs	1 Piece(s)

Switching outputs	
Type	Digital switching output
Voltage type	DC

Switching output 1	
Assignment	Connection 1, conductor 2
Switching element	Transistor, NPN
Switching principle	NC (normally closed)

Timing	
Switching frequency	100 Hz

Connection	
Number of connections	1 Piece(s)

Connection 1	
Type of connection	Cable
Cable length	2,000 mm
Sheathing material	PVC
Number of conductors	3 -wire
Wire cross section	0.35 mm ²

Mechanical data	
Design	Cylindrical
Thread size	M18 x 1 mm
Dimension (Ø x L)	18 mm x 70 mm
Type of installation	Embedded
Housing material	Metal
Sensing face material	Plastic, Polybutylene (PBT)
Cover material	Plastic, Polybutylene (PBT)

Operation and display	
Type of display	LED
Number of LEDs	1 Piece(s)
Switching distance, adjustable	Yes

Part no.: 50136540 – LCS-2M18B-F08NNC-K020V – Capacitive sensor
Environmental data

Ambient temperature, operation	-25 ... 70 °C
--------------------------------	---------------

Certifications

Degree of protection	IP 67
Protection class	III
Standards applied	IEC 60947-5-2

Correction factors

Acetone	0.75
Acrylic resin	0.1 ... 0.25
Alcohol	0.85
Ammonia	0.7 ... 0.85
Aniline	0.4
Gasoline	0.1
Celluloid	0.15
Liquid chlorine	0.1
Ebonite	0.15
Epoxy resin	0.15 ... 0.35
Crude oil	0.05
Ethanol	0.85
Ethylene glycol	0.93
Freon R22 and 502 (liquid)	0.35
Grain	0.15 ... 0.3
Glass	0.2 ... 0.55
Glycerin	0.98
Rubber	0.15 ... 0.9
Wood, wet	0.6 ... 0.85
Wood, dry	0.1 ... 0.4
Marble	0.5
Flour	0.05
Melamine resin	0.25 ... 0.55
Milk powder	0.2
Nylon	0.2 ... 0.3
Oil-containing paper	0.25
Paper	0.1
Polyamide	0.3
Polyester resin	0.15 ... 0.5
Pressboard	0.1 ... 0.3
PTFE	0.1
Quartz glass	0.2
Salt	0.35
Sand	0.15 ... 0.3
Water	1
Cement dust	0.25
Sugar	0.15

Classification

eCl@ss 8.0	27270102
eCl@ss 9.0	27270102

Dimensioned drawings

All dimensions in millimeters

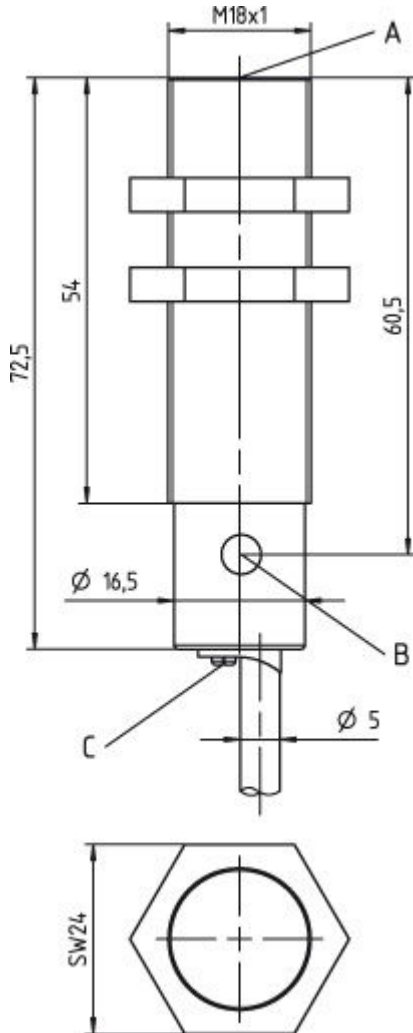

- A Active surface
- B Yellow LED
- C Potentiometer

Electrical connection

Connection 1	
Type of connection	Cable
Function	
Cable length	2,000 mm
Sheathing material	PVC
Cable color	

Part no.: 50136540 – LCS-2M18B-F08NNC-K020V – Capacitive sensor

Connection 1	
Number of conductors	3 -wire
Wire cross section	0.35 mm ²

Conductor color	Conductor assignment
Brown	10 - 30 V DC
Black	OUT
Blue	GND

Circuit diagrams

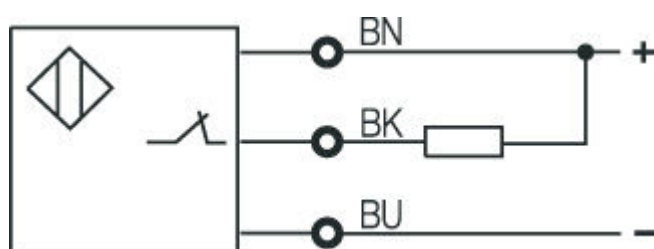

Operation and display

LEDs

LED	Display	Meaning
1	Yellow, continuous light	Switching output/switching state

Accessories

Mounting technology - Mounting brackets



	Part no.	Designation	Article	Description
	50113548	BT D18M.5	Mounting bracket	Diameter, inner: 18 mm Design of mounting device: Angle, L-shape Mounting bracket, at system: Through-hole mounting Mounting bracket, at device: Screw type Type of mounting device: Rigid Material: Stainless steel

Part no.: 50136540 – LCS-2M18B-F08NNC-K020V – Capacitive sensor

Mounting technology - Rod mounts

	Part no.	Designation	Article	Description
	50117490	BTU D18M-D12	Mounting system	Design of mounting device: Mounting system Mounting bracket, at system: Through-hole mounting Mounting bracket, at device: Screw type Type of mounting device: Clampable, Adjustable, Turning, 360° Material: Metal

Mounting technology - Other

	Part no.	Designation	Article	Description
	50132729	AC D18M-CS	Clamp	Contains: 2x M24 mounting nut Diameter, inner: 18 mm Design of mounting device: Mounting clamp Mounting bracket, at system: Screw type, Through-hole mounting Mounting bracket, at device: Insertable, Clampable with limit stop Type of mounting device: Clampable, With limit stop Material: Metal
	50111501	MC 018K	Clamp	Diameter, inner: 18 mm Design of mounting device: Mounting clamp Mounting bracket, at system: Through-hole mounting Mounting bracket, at device: Clampable Type of mounting device: Rigid Material: Plastic
	50111502	MC 018K-LS	Clamp	Diameter, inner: 18 mm Design of mounting device: Mounting clamp Mounting bracket, at system: Through-hole mounting Mounting bracket, at device: Clampable with limit stop Type of mounting device: Rigid Material: Plastic

Notes

Observe intended use!

- This product is not a safety sensor and is not intended as personnel protection.
- The product may only be put into operation by competent persons.
- Only use the product in accordance with its intended use.